

QUATTRO™

spinal system

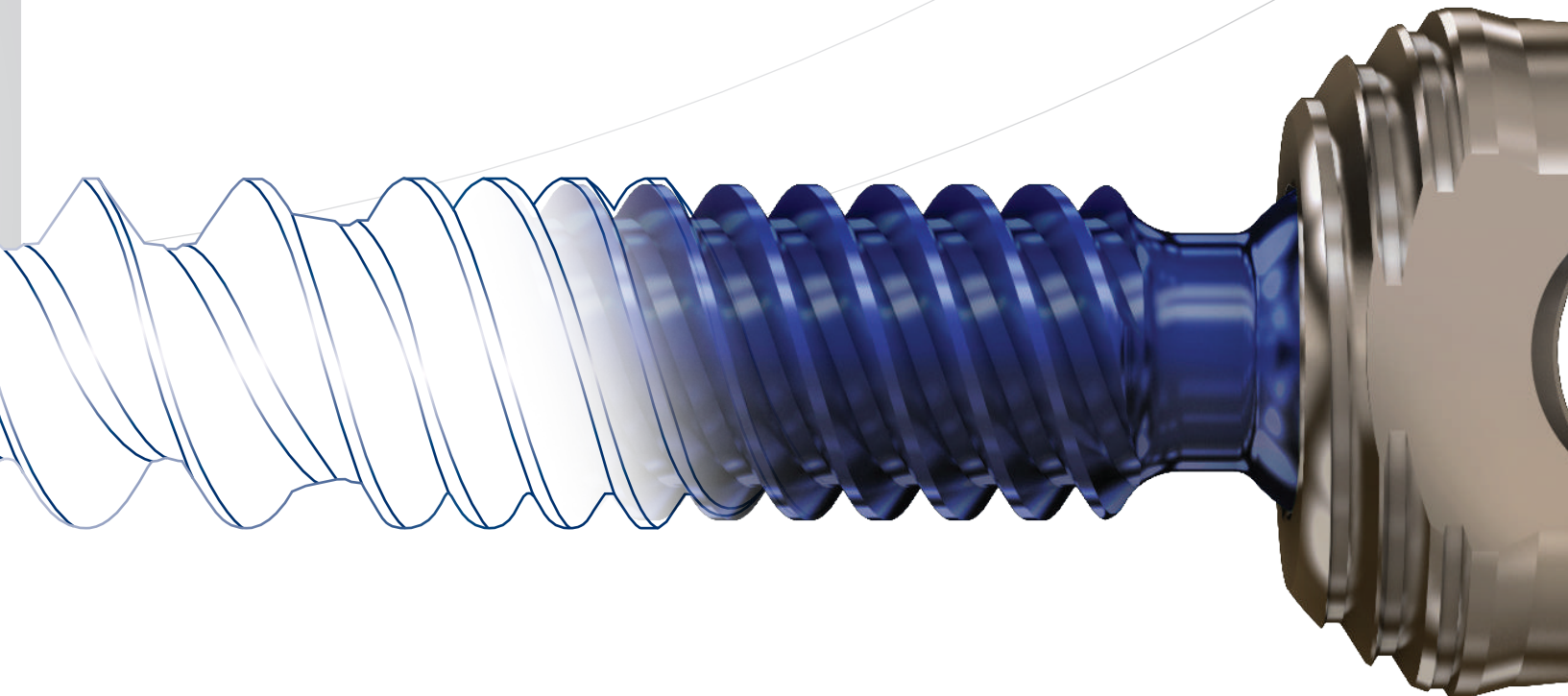

Top to Tip Quad Lead

Minimizing operation time and strong enough
bone purchasing force with Top to Tip Quad Lead design
pedicle screw system



TTQ SCREW DESIGN

Top to Tip Quad Lead

Patented TTQ (Top to Tip Quad Lead) screw design minimizes operation time compare to standard (or dual lead) one and maximizes the bone purchasing force through providing optimal contact surface each part of the vertebrae.

Experience the power & speed of 4 leads fixation!

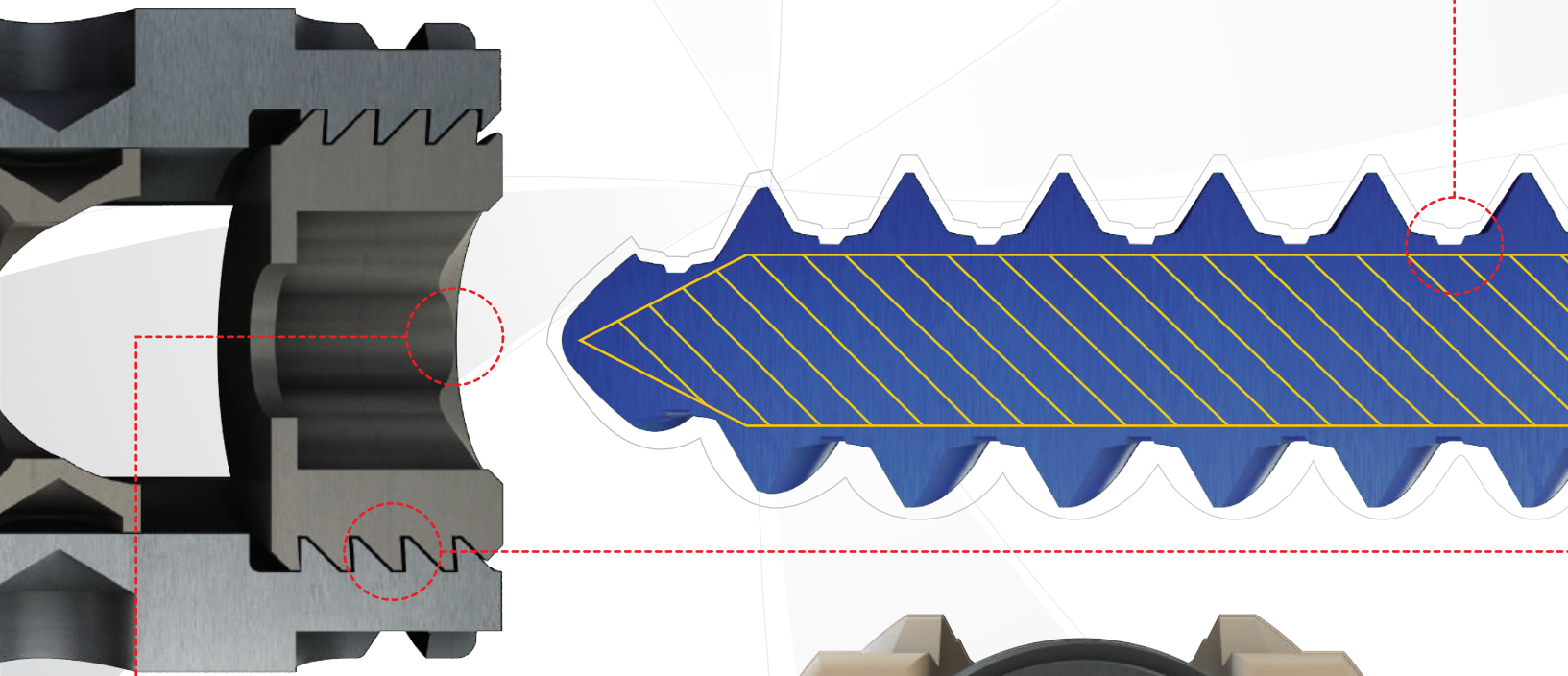

Torx head set screw

- ⊕ Secures engagement minimize slippage of a screwdriver on the screw head
- ⊕ Minimizes screw head/screw driver tip damage

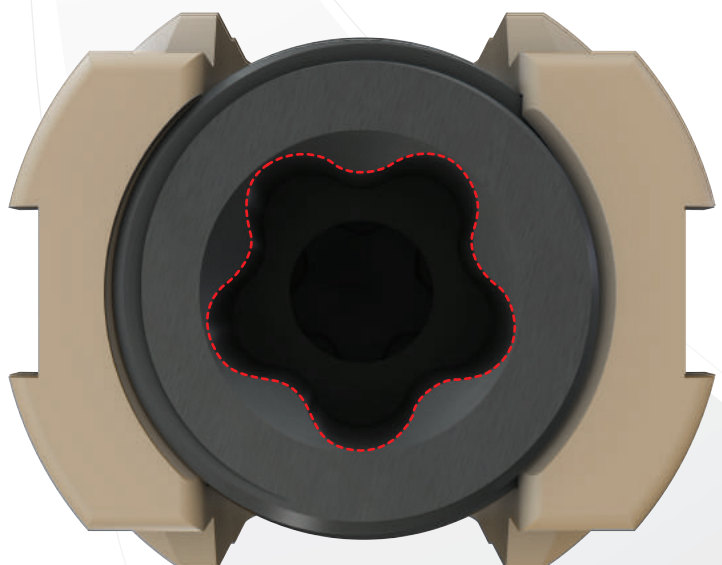

TTQ Cortical Zone

- ⊕ Enhances fixation to prevent the screw pull out by doubling the number of contact points with cortical bone
- ⊕ Prevents the screw neck breakage / toggle

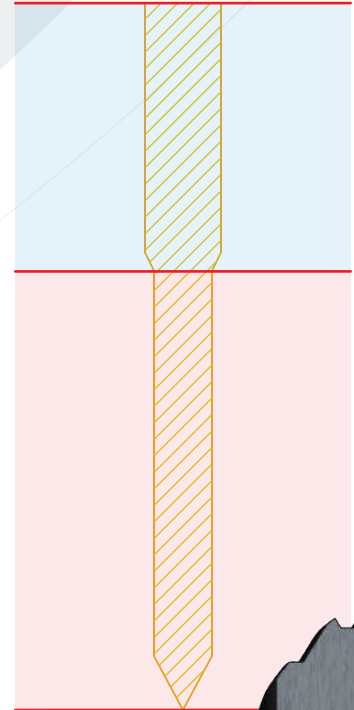
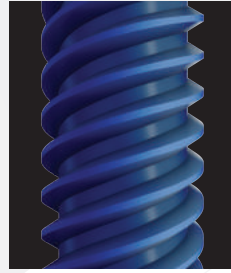

TTQ Cancellous Zone

- ⊕ Enables faster screw insertion into the pedicle
- ⊕ Provides stronger bone purchasing force by holding the larger cancellous bone fragment
- ⊕ Prevents the lucency around screw on x-rays

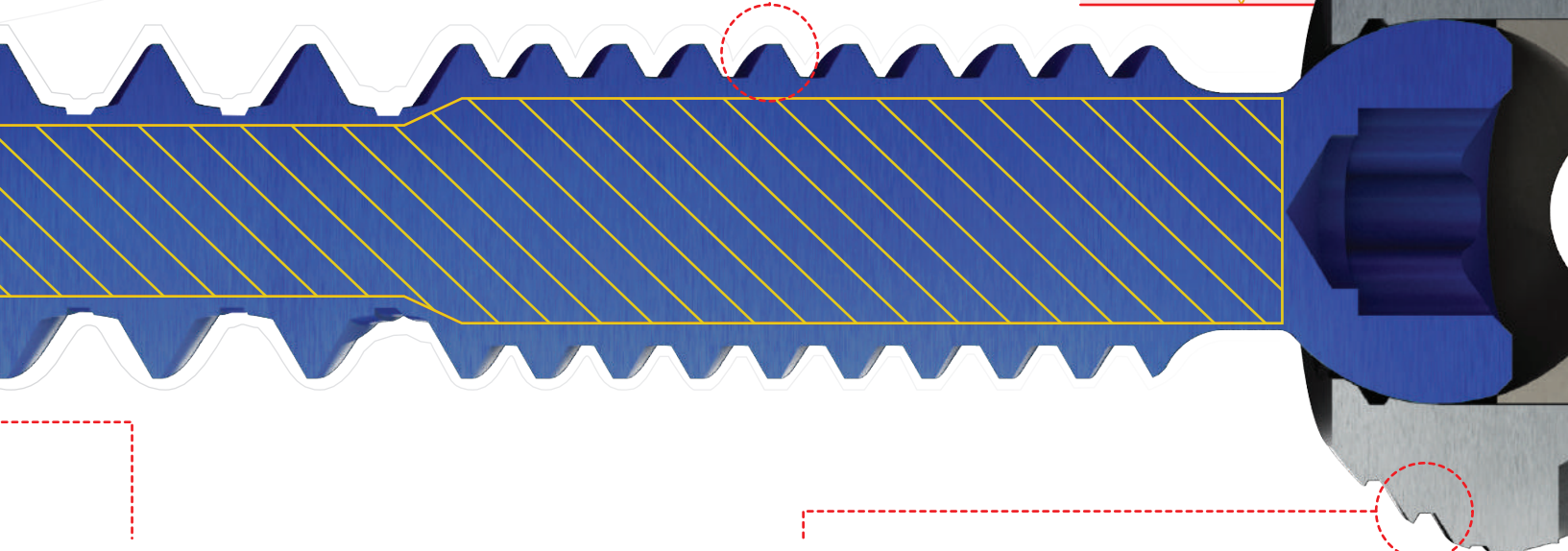

Buttress thread

- ⊕ Enhances security
- ⊕ Minimizes the screw head spreading

Threaded Bottom Anchor

- ⊕ Enables screw head placement to fit in the posterior pedicle wall firmly

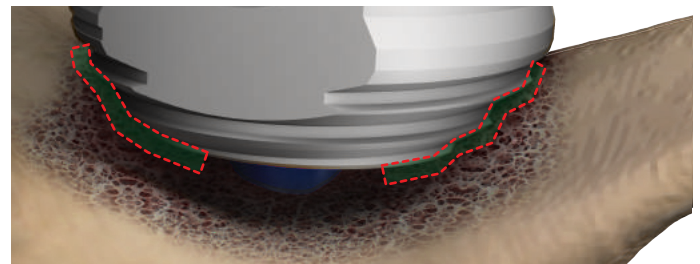
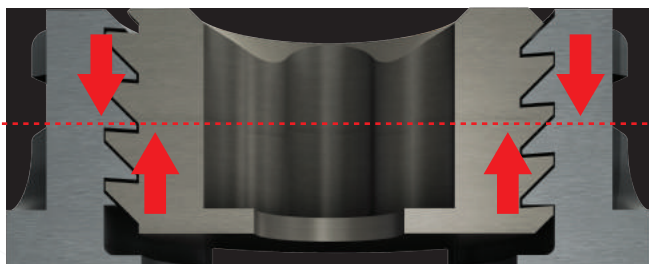

IMPLANT

Catalog No. A1 - xxxx - A01
 Description Mono Screw \varnothing 4.5 ~ 8.0
 20 ~ 100 mm



A1 - xxxx - A03
 Mono Reduction Screw \varnothing 4.5 ~ 8.0
 20 ~ 100 mm



Catalog No. A1 - xxxx - A11
 Description Poly Screw \varnothing 4.5 ~ 8.0
 20 ~ 100 mm



A1 - xxxx - A13
 Poly Reduction Screw \varnothing 4.5 ~ 8.0
 20 ~ 100 mm



A1 - xxxx - B11
 Poly Screw (Standard) \varnothing 4.5 ~ 8.0
 20 ~ 100 mm



Catalog No. A1 - 0000 - A01
 Description Set Screw



Catalog No. AZ - 5500 - xxx
 Description Straight Rod, Normal \varnothing 5.5
 20 ~ 100 mm



AZ - 5502 - xxx
 Prebent Rod, Normal \varnothing 5.5
 20 ~ 100 mm



Catalog No. AZ - 3034 - 001
 Description Cross - Link 30 - 34 mm



AZ - 3340 - 001
 Cross - Link 33 - 40 mm



AZ - 3850 - 001
 Cross - Link 38 - 50 mm



AZ - 4870 - 001
 Cross - Link 48 - 70 mm



INSTRUMENTS TRAY

Catalog No. AZA - Z010
 Description QUATTRO instrument tray





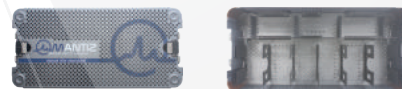



Catalog No. AZA - Z011
 Description QUATTRO instrument tray



Catalog No. AZA - Z011 - XXX
 Description QUATTRO accessory caddy









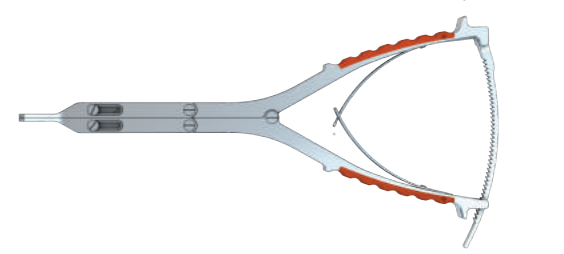

INSTRUMENTS

Catalog No.	A1A - 1010	
Description	Guide Pin, left	
	A1A - 1011	
	Guide Pin, right	
Catalog No.	A1A - 1050	
Description	Awl	
Catalog No.	A1A - 1013	
Description	Probe, straight	
	A1A - 1014	
	Probe, curved	
Catalog No.	A1A - 1015	
Description	Tester	
Catalog No.	A1A - 1016	
Description	Tapper 4.3mm	
	A1A - 1018	
	Tapper 5.0mm	
	A1A - 1020	
	Tapper 6.0mm	
	A1A - 1022	
	Tapper 7.0mm	
Catalog No.	A1A - 1055	
Description	Mono Screw Driver	
	A1A - 1052	
	Poly Screw Driver Shaft Long	
	A1A - 1053	
	Screw Driver Outer Sleeve Long	
Catalog No.	A1A - 1028	
Description	Long Arm Cutter	

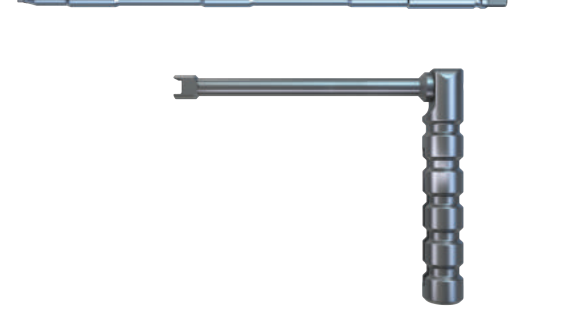

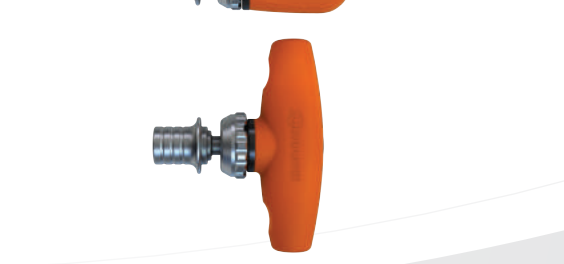
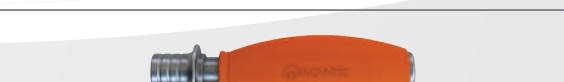
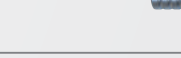
Catalog No. Description	A1A - 1029 Rod Holder, Straight	
Catalog No. Description	A1A - 1031 Rod Gripper	
Catalog No. Description	A1A - 1032 Rod Bender	
Catalog No. Description	A1A - 1033 Rod Pusher	
Catalog No. Description	A1A - 1034 Long Locker	
Catalog No. Description	A1A - 1035 Reducer	
Catalog No. Description	A1A - 1036 Set Screw Driver Starter	
	A1A - 1049 Set Screw Driver Starter(Handle Type)	
Catalog No. Description	A1A - 1037 Set Screw Driver, short	
	A1A - 1038 Set Screw Driver, long	
Catalog No. Description	A1A - 1039 Anti - Torque Wrench	



Catalog No. Description	A1A - 1040 Compressor		
	A1A - 1041 Distractor		
Catalog No. Description	A1A - 1045 Cross-link Driver		
	A1A - 1046 Cross-link Wrench		
Catalog No. Description	A1A - 1042 I-Handle, Ratchet		
	A1A - 1043 Parm Handle, Ratchet		
	A1A - 1047 T-Handle, Ratchet		
Catalog No. Description	A1A - 1048 I-Handle, Simple		
Catalog No. Description	A1A - 1054 Torque Limited Handle 5Nm		
	A1A - 1044 Torque Limited Handle 12Nm		

[above the standard]

QUATTROTM
spinal system

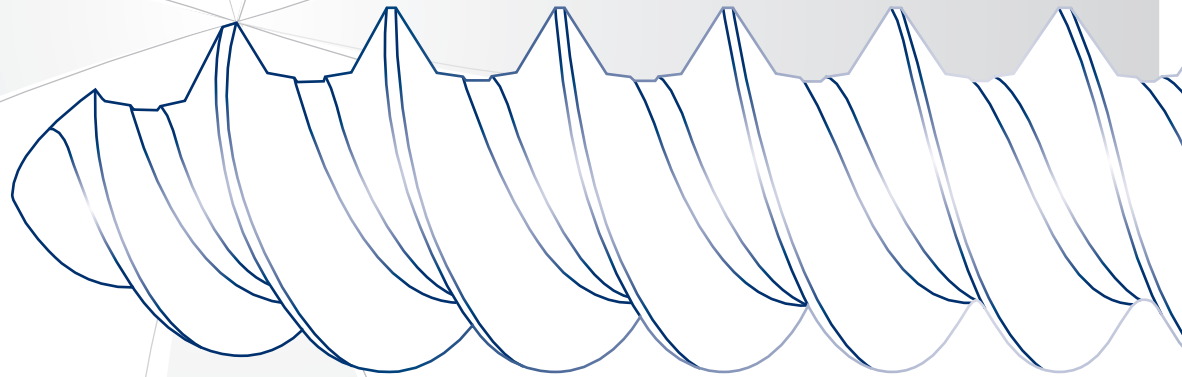

Headquarter

Ant building, 38, Chungui-ro, Suseong-gu,
Daegu, Korea ☎ 42052
TEL +82(0)53 252 5833 FAX +82(0)53 252 5834

• **Seoul office**

1507, STX W Tower, 90, Gyeongin-ro, 53-gil,
Guro-gu, Seoul, Korea ☎ 08215
TEL +82(0)2 864 5833 FAX +82(0)2 864 5834

• **Busan office**

912, ACE High tech21, 48, Centum jungang-ro,
Haeundae-gu, Busan, Korea ☎ 48059
TEL +82(0)51 465 7117 FAX +82(0)51 465 7167